

RoHS

Reach

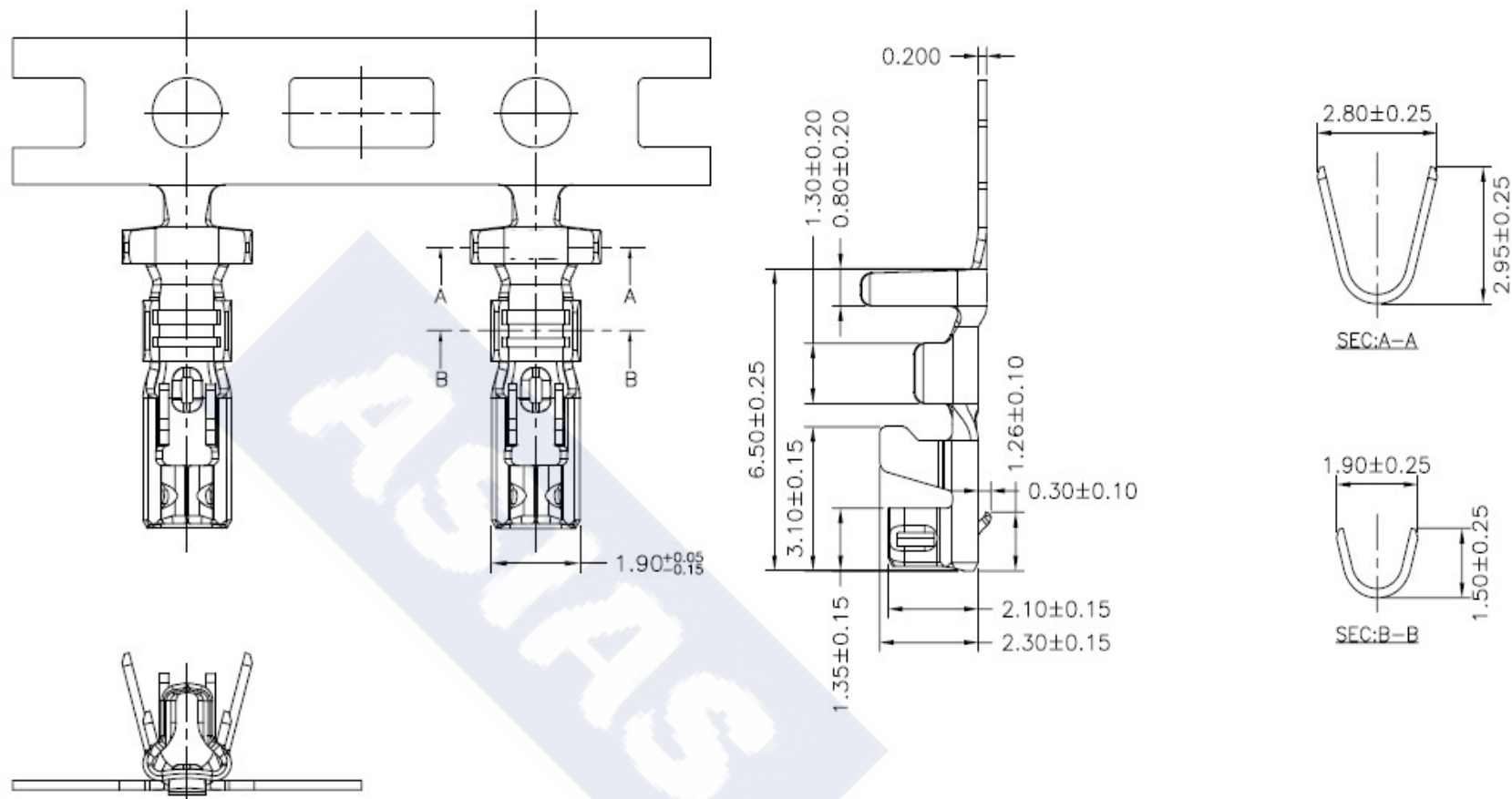

## Ordering Information &amp; Specification

Part NO.	Wire Range	Insulation O.D.	Material	Finish	SPQ
2508JT-TP	AWG#22~AWG#28	1.90mm(max)	Phosphor Bronze	Tin-plated	8,000 pcs/reel

\*\* Stamping before plating

**ASIAS** ASIAS TECHNOLOGY CO.,LTD.

DESCRIPTION :  
**2.50mm Pitch,  
Crimp Terminal**

PART NO. :  
**2508JT-TP**

## GENERAL TOLERANCE

X.X  $\pm 0.25$   
X.XX  $\pm 0.15$   
X.XXX  $\pm 0.05$

SCALE : Free

