

RoHS

Reach

Explanation of PN.

0500J R T S XX - 6 NL X X
 ① ② ③ ④ ⑤ ⑥ ⑦ ⑧ ⑨

Ordering Information & Dimension

Circuit No.	Dimensions				Circuit No.	Dimensions			
	A	B	C	D		A	B	C	D
04P	1.50	7.70	2.60	0.300	25P	12.00	18.20	13.10	0.350
05P	2.00	8.20	3.10	0.300	26P	12.50	18.70	13.60	0.350
06P	2.50	8.70	3.60	0.300	27P	13.00	19.20	14.10	0.350
07P	3.00	9.20	4.10	0.350	28P	13.50	19.70	14.60	0.350
08P	3.50	9.70	4.60	0.350	29P	14.00	20.20	15.10	0.350
09P	4.00	10.20	5.10	0.350	30P	14.50	20.70	15.60	0.350
10P	4.50	10.70	5.60	0.350	31P	15.00	21.20	16.10	0.350
11P	5.00	11.20	6.10	0.350	32P	15.50	21.70	16.60	0.350
12P	5.50	11.70	6.60	0.350	33P	16.00	22.20	17.10	0.350
13P	6.00	12.20	7.10	0.350	34P	16.50	22.70	17.60	0.350
14P	6.50	12.70	7.60	0.350	35P	17.00	23.20	18.10	0.350
15P	7.00	13.20	8.10	0.350	36P	17.50	23.70	18.60	0.350
16P	7.50	13.70	8.60	0.350	37P	18.00	24.20	19.10	0.350
17P	8.00	14.20	9.10	0.350	38P	18.50	24.70	19.60	0.350
18P	8.50	14.70	9.60	0.350	39P	19.00	25.20	20.10	0.350
19P	9.00	15.20	10.10	0.350	40P	19.50	25.70	20.60	0.350
20P	9.50	15.70	10.60	0.350	45P	22.00	28.20	23.10	0.350
21P	10.00	16.20	11.10	0.350	49P	24.00	30.20	25.10	0.350
22P	10.50	16.70	11.60	0.350	50P	24.50	30.70	25.60	0.350
23P	11.00	17.20	12.10	0.350	51P	25.00	31.20	26.10	0.350
24P	11.50	17.70	12.60	0.350					

- ① Series No.
- ② Connector Type : Right Angle
- ③ Option Type : Top Contact Type
- ④ Mounting Type : SMD
- ⑤ Circuits No.
- ⑥ Insulator Material : Housing : LCP, UL 94-V0
Actuator : Nylon6T, UL 94-V0
- ⑦ Color : Housing : Natural(Beige)
Actuator : Black
- ⑧ Contact Plating : 0.Matte Tin-plated ; 2.Gold-flash
- ⑨ Soldering Tab : 0.Matte Tin-plated ; 2.Gold-flash

Specification :

- Current Rating : 0.5A AC,DC
- Voltage Rating : 50V AC,DC
- Temperature Range : -25°C ~ +85°C
- Contact Resistance : 30mΩ Max.
- Insulation Resistance : 100mΩ Min.
- Withstanding Voltage : 250V AC/minute
- Pin Material : Phosphor Bronze
- Soldering Tab : Brass
- Insulator Material : Housing : LCP, UL 94-V0
Actuator : Nylon 6T, UL 94-V0

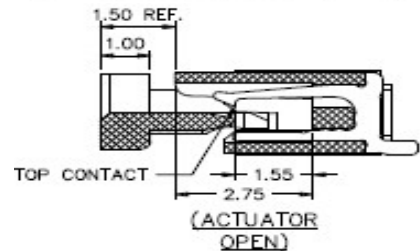
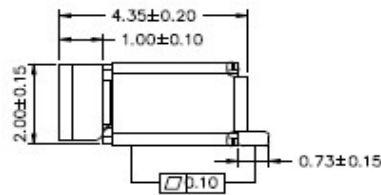
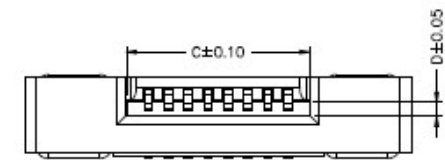
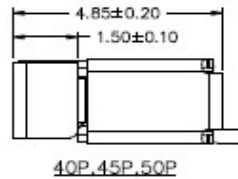
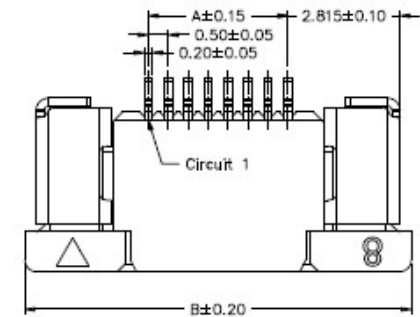
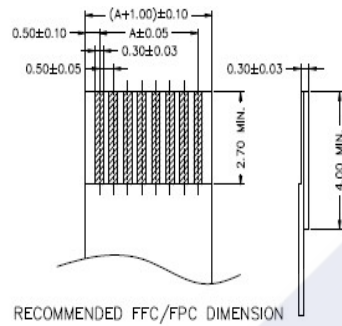
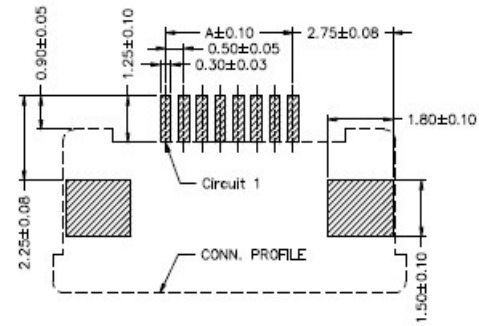

	DESCRIPTION : 0.50mm Pitch, FPC, ZIF, SMD, Right Angle, Top Contact Type	GENERAL TOLERANCE	
	PART NO. : 0500JRTSXX-6NLXX	X.X ± 0.25 X.XX ± 0.15 X.XXX ± 0.05	SCALE : Free